

ST SERIES SUB-MINIATURE TOGGLE SWITCH



1. RATING : Q TYPE : 120 V AC , 3 A or 28 V DC ; 250 V AC , 1A .
R TYPE : 0.4 VA MAX , 20 V (AC or DC) MAX .
2. CONTACT RESISTANCE : 20 mΩ MAX .
3. INSULATION RESISTANCE : 1,000 MΩ MIN .
4. OPERATING TEMPERATURE : -30°C ~ 85°C .
5. OPERATING LIFE : 30,000 CYCLES .

TYPE:

S TYPE

A TYPE

B TYPE

P TYPE

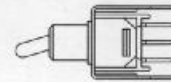
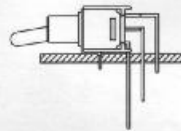
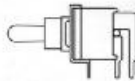
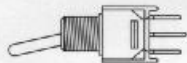

S TYPE
1 POLE

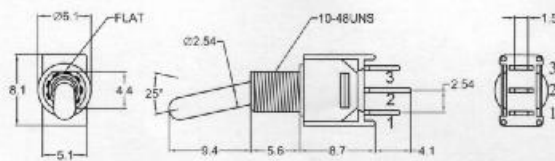

2 POLE

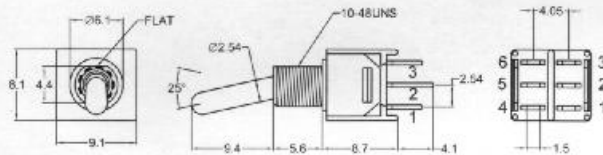

A TYPE
1 POLE

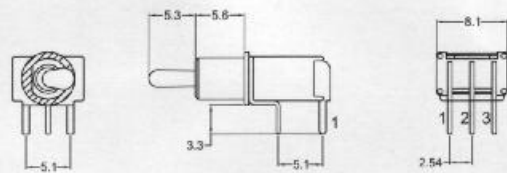

2 POLE

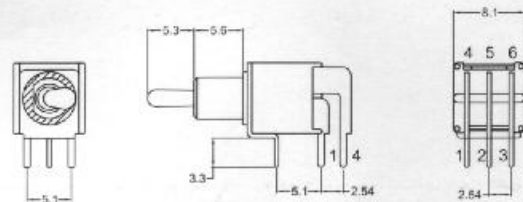

B TYPE
1 POLE

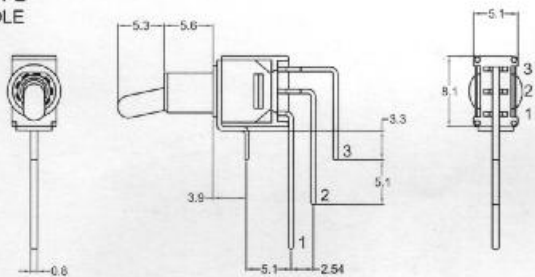

2 POLE

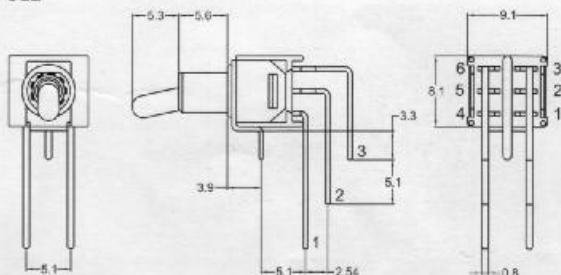

P TYPE
1 POLE

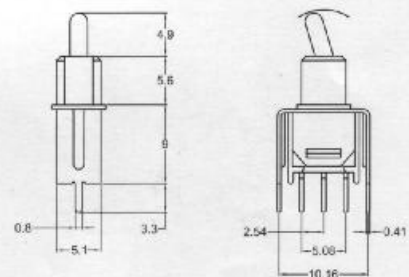

2 POLE

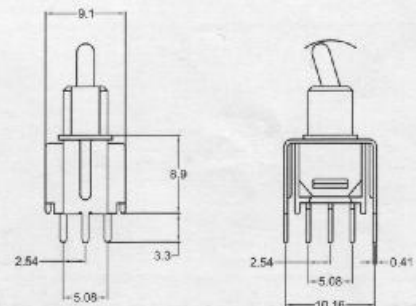

ST SERIES SUB-MINIATURE TOGGLE SWITCH

POSITION :

TERMINAL OPTIONS :

| CODE | SWITCHING POSITION | | |
|------|--------------------|------|------|
| | 1 | ON | NONE |
| 2 | ON | NONE | (ON) |
| 3 | ON | OFF | ON |
| 4 | (ON) | OFF | (ON) |
| 5 | ON | OFF | (ON) |

W (STD)

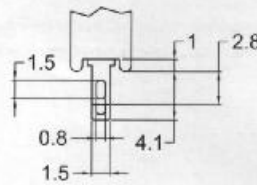

P (P.C.B)

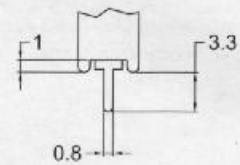

ACTUATOR OPTIONS :

S STD

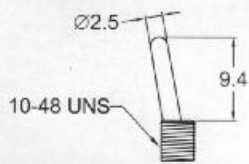

T (STD.)
ON P.C.Models

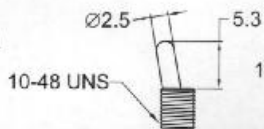

U

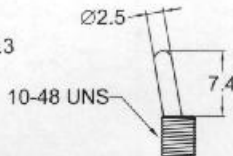

V

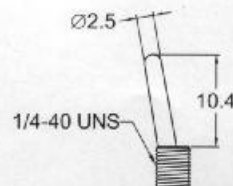

X
NOT AVAILABLE

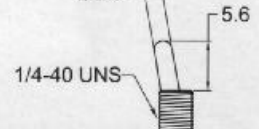

BUSHING OPTIONS :

B1 THD.STD

B2 NON THD.STD.ON P.C. MODEL

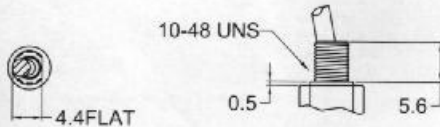

B3 THD

B4 NON THD

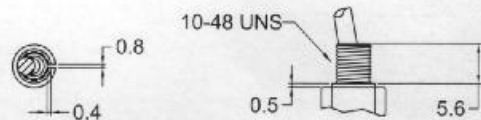

B5 THD

B6 NON THD

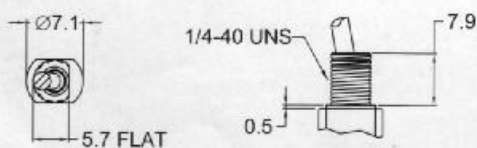

B7 THD

B8 NON THD

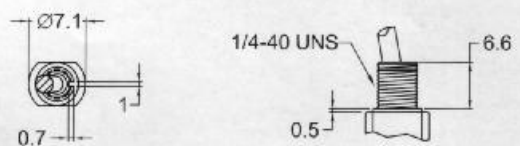

CONTACT MATERIAL :

Q

END CONTACTS: Coin silver, silver plated.

CENTER CONTACT & ALL TERMINALS:

Brass, silver plated.

RATING : 120 V AC or 28 V DC .

250 V AC , 1 A .

R

CONTACTS & TERMINALS: Brass,

with gold plated over nickel plated.

RATING : 0.4 VA MAX .

20 V (AC or DC) MAX .

HOW TO ORDER

